

MEDIUM VOLTAGE IEGT INVERTER/CONVERTER
TMdrive™-70e3
series



TMEIC Corporation

Global Headquarters TMEIC Corporation
Tokyo Square Garden, 3-1-1 Kyobashi, Chuo-ku, Tokyo 104-0031, Japan
Tel. : +81-3-3277-5915
Fax : +81-3-3277-4562
Web : www.tmeic.co.jp

North America TMEIC Corporation Americas
Office Location: 1325 Electric Road, Roanoke VA 24018 U.S.A.
Mailing / Receiving Address: 2060 Cook Drive, Salem, Virginia 24153 U.S.A.
Phone: +1-540-283-2000
Fax : +1-540-283-2001

- TOSLINE and TC-net are trademarks of Toshiba Corporation.
- TMdrive is a trademark of TMEIC Corporation.
- Ethernet is a registered trademark of FUJIFILM Business Innovation Corp.
- DeviceNet is a trademark of The Open DeviceNet Vendor Association.
- PROFIBUS is DIN19245 (German Industrial Standard) and EN50170 (European Standard).
- Modbus is a registered trademark of Schneider Electric.
- Windows is a registered trademark or trademark of Microsoft Corporation in the United States and other countries.
- Product names in this catalog may be used as trademarks or registered trademarks of their respective companies.
- Please note that the contents of the materials are subject to change without notice.
- PROFIBUS / PROFINET are registered trademarks of PROFIBUS Nutzerorganisation e.V (.PNO).
- QR code is a registered trademark of DENSO WAVE INCORPORATED.



Safety precautions

- For safe and correct use, be sure to read the "Handling and Operation Manual" carefully before use.

B-D059-2304-A(Hearts)



TMdrive-70e3 Industrial high-performance drive that combines the latest power electronics technology and IoT / digitalization technology

TMdrive-70e3 is a water cooled, 3-level, IEGT based, medium voltage Variable Frequency Drive. This drive is next in series of TMdrive-70 and TMdrive-70e2 which has a successful track record of more than 2000 installed modules around the world for Industrial applications. TMdrive-70e3 builds on high reliability and high-performance motor control that surpasses conventional models of TMdrive-70 and TMdrive-70e2. By incorporating latest power electronics and digitalization technologies, TMdrive-70e3 aims to enhance maintainability, operational efficiency and plant digitalization.

Contribution to plant digitalization



TMdrive-70e3

Connection with various PLCs

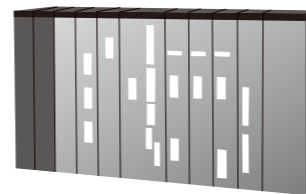

Proven power electronics technology from TMdrive series

Specializing in plant control



High-speed, high-precision motor control

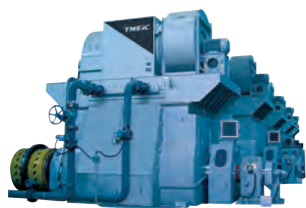

Collection and analysis of field data



Improved maintainability
Downtime reduction



World class diagnostic tools

Compact and Highly Efficient TMdrive-70e3 Series

Compact size due to use of pack type power devices, water cooling of power electronics, optimized circuit boards and 99% converter efficiency.

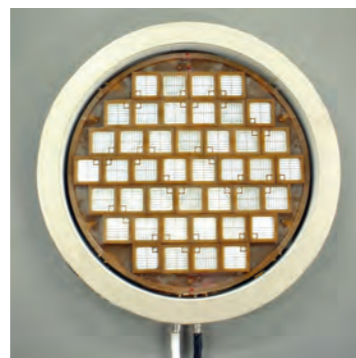

9MVA model IEGT power device



TMdrive-70e3

Helps achieve plant Digitalization

A Data collection function

Plant Digitalization can be achieved by using the data collected by TMdrive-70e3 such as motor currents, motor voltage, motor speed, self-diagnostics and field data from various sensors. TMdrive-70e3 uses extended inputs / outputs to collect field data. It can uniquely process data based on the application. It can store data temporarily using a buffer or it can store long-term history data using built-in SD card. A faster data collection and enhanced security is achieved by isolating Control Network from Diagnostic Network.

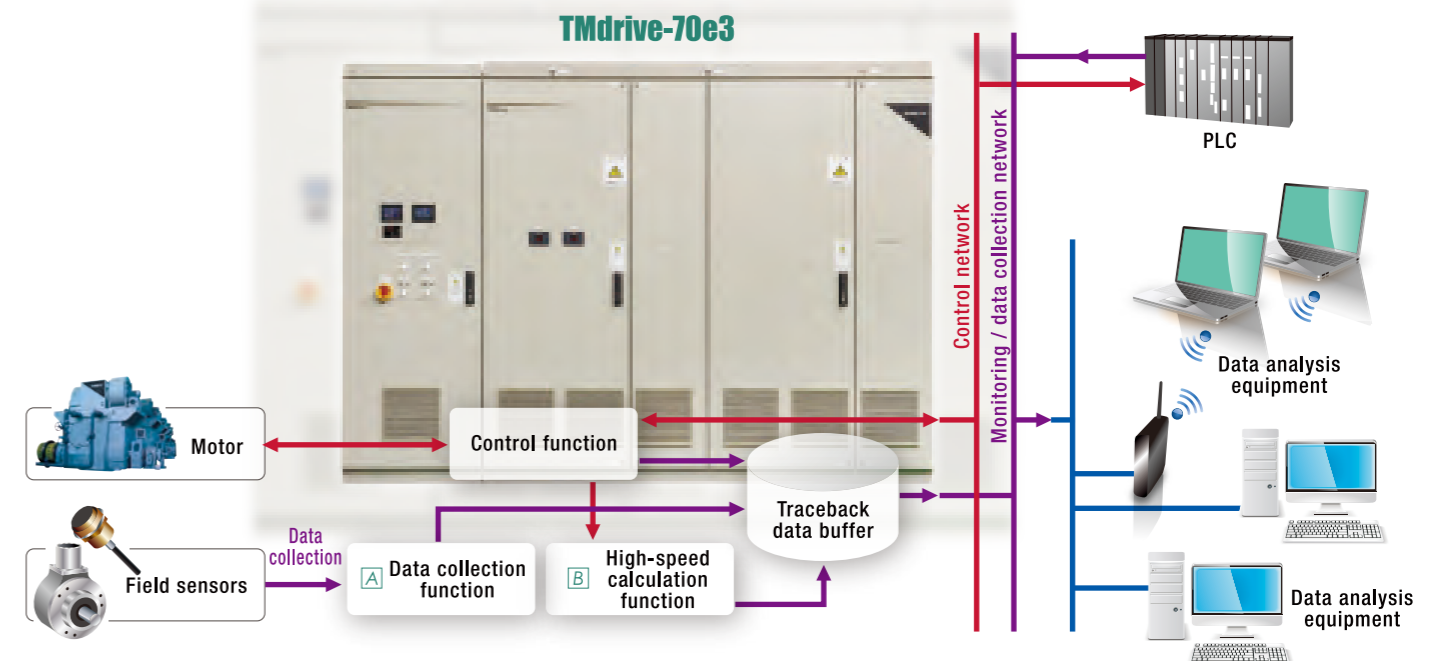

B High-speed calculation function

The high-speed calculation function enables high-speed sampling and high-speed analysis of functions such as frequency domain analysis. TMdrive-70e3 can store high-speed data and results of high-speed calculations in a temporary buffer and it can broadcast them to external supervisory / diagnostic devices. Due to separation of Control Network from Data collection / diagnostics Network as well as of Control Function from High-Speed Analysis function, impact on CPU processing power and motor control is avoided.

Drive Specialized for Plant Control

TMdrive-70e3 has built-in micro PLC which can be programmed to add simple ladder logic functions or simple application specific functions.

In addition, the number of external signal input / output points can be expanded by connecting additional I/O boards.

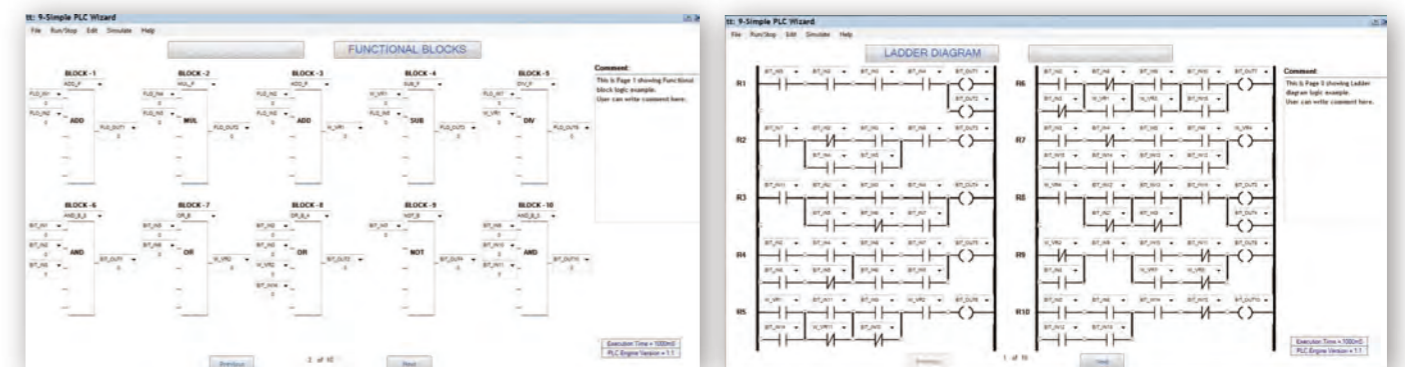

User-defined functions

Ladder sequence

The maximum I/O points for each type: Analog input 8 ch max., analog output 8 ch max., digital input 16 ch max., digital output 16 ch max., RTD input 2 ch max.

High Performance and High Functionality

Versatile control functions backed by a wealth of experience in main drives for ferrous and non-ferrous rolling mills

- Fixed pulse pattern converter**
 TMdrive-70e3 converter control builds on proven, high-efficiency control that is tolerant to power supply fluctuations, can improve voltage fluctuations and has less harmonics.
- SFC (simulator following control)**
 It reduces the influence of the torsional vibration system of the drive shaft and achieves higher control response.
- RMFC (reference model following control)**
 By adding a reference model (speed control + mechanical model) and constructing a two-degree-of-freedom control system, speed uniformity and disturbance load response are improved.
- Impact monitor function**
 A function that estimates the rolling torque at metal-in and reduces the impact related drop in speed during rolling.. Function is integral to VFD.
- New magnetic flux control for synchronous motors**
 Magnetic flux control, based on electromagnetic field analysis data, accurately captures the characteristics of synchronous motors, achieves high adjustment accuracy, and shortens the time required for on-site parameter tuning.
- Field polarity switching**
 The field polarity can be reversed by switching the conductor connections inside the panel. Helps prevent roughening of the slip ring surface of the synchronous motor.

Main Circuit Configuration

Realization of flexible and diverse configurations by expanding the lineup

The lineup has been expanded compared to the previous lineups, and it is now possible to drive a wide range of motors with the optimum frame. Ability to combine different Frame sizes to form a common DC Bus solution offers greater flexibility and versatility based on motor / application requirements without need to use larger frame.

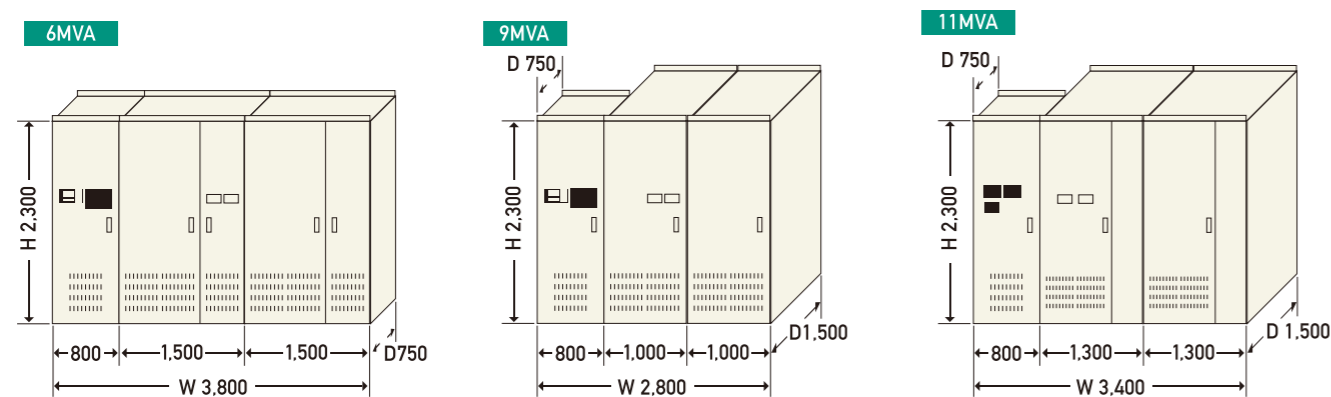

Panel configuration example combining different frames

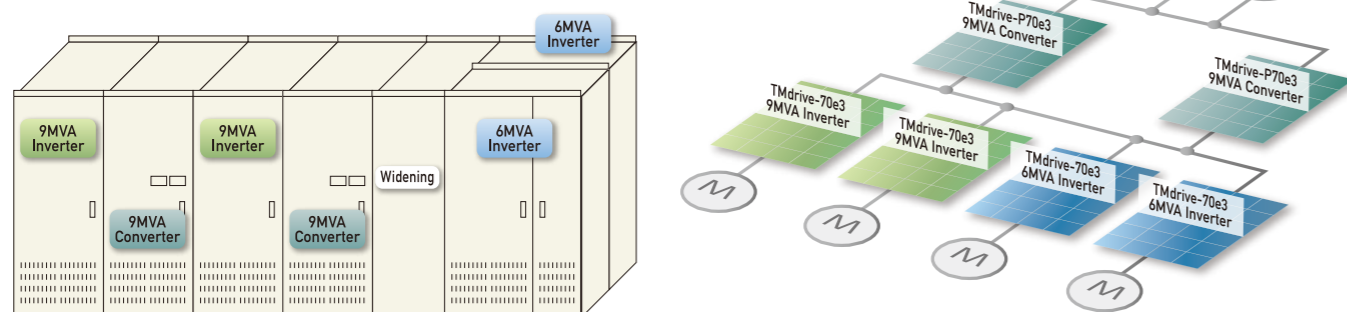

Drive System Friendly to the Power Supply System

TMEIC original high-efficiency fixed pulse pattern converter control

Unique converter control scheme that is tolerant to power supply fluctuations, can help improve voltage fluctuations by injecting VARs and causes lower harmonic distortion.

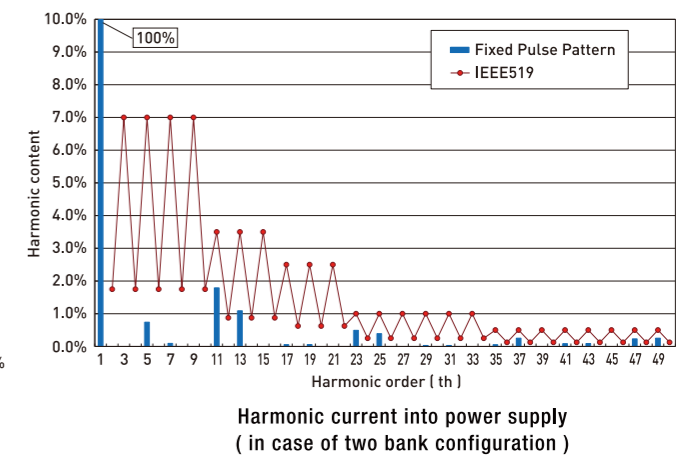
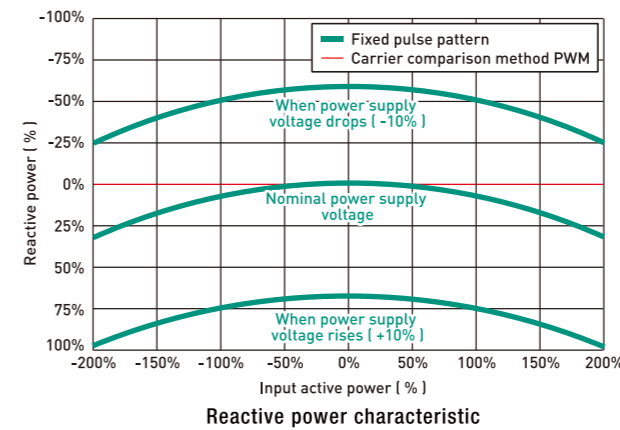

IEGT Power Module

Further improved IEGT power module

IEGT stack structure is optimized further to reduce downtime by improving footprint and weight. Use of film capacitors improves maintainability of the drive.

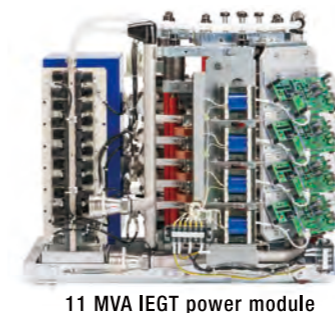

Adaptor

The IEGT power module of the TMdrive-70e3 11MVA frame can be applied to TMdrive-70e2 / -70e3 9 MVA frames by attaching bus adapters.

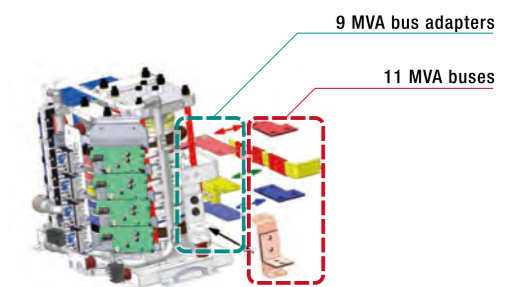

Versatile Serial Communication Interface

Wide selection of serial communication interface cards enables interface with various PLCs.

It has a configuration suitable for the next generation control system using the Unified Controller nv series and Vm series typeS and it is also easy to communicate with the existing master controller.

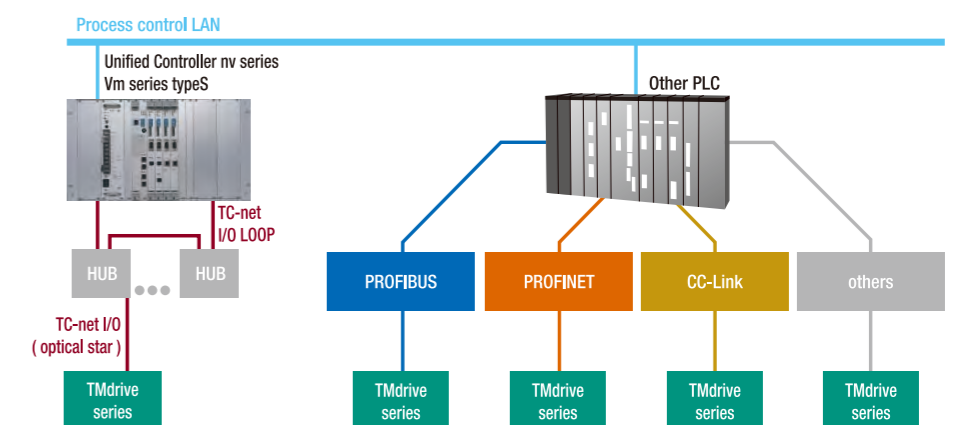

The Group of Tools that Improve Maintainability

TMdrive-Navigator

TMdrive-Navigator is a world class tool that can be used to adjust and / or monitor drive parameters. In addition to individual parameter adjustments, it is now possible to change a group of parameters specific to a function or application. It is also possible to fine tune parameters to "increase response" or "suppress vibrations" to improve motor control and process performance. In the event of failures, TMdrive-70e3 can store a larger number of Traceback files and with a longer duration than TMdrive-70e2, allowing a better fault diagnosis.

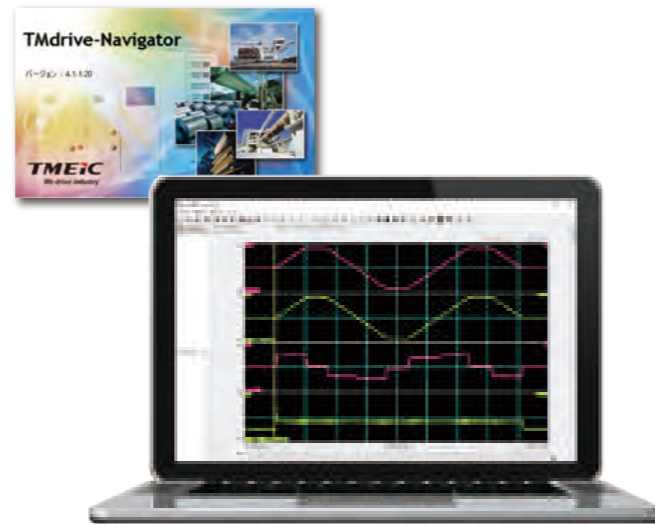

TMdrive-Monitor

It is possible to monitor the driving status and failure information of the drive from a smartphone or tablet. Traceback data can be uploaded when a failure occurs.



Usage image

TMdrive-Support

A QR code will be displayed on the operation panel on the drive panel. By reading the QR code with a smartphone or tablet with TMdrive-Support installed, device information such as ratings can be obtained. In addition, by reading the QR code that is displayed at the time of failure, troubleshooting for the corresponding failure will be displayed on the smartphone or tablet.



Downtime Reduction

Parameter Migration

When replacing the CTR board (main control board), it is possible to take over the drive information by inserting the SD card with the saved parameters into the new board.

Preventive maintenance

TMdrive-70e3 tracks operation time of certain parts within the drive. To complement preventive maintenance, TMdrive-70e3 will announce when a particular component is approaching end of its recommended operating life.

Functional Safety

Equipped with safety functions that comply with the functional safety standard IEC / EN 61800-5-2 (*1). As an option, STO, SS1, SLS, SBC, and SSM safety functions can be realized with SIL 3 and PL e.

	Safety function		performance level	Remarks
standard	STO	Safe Torque Off	SIL 2 • PL d	
option	STO	Safe Torque Off	SIL 3 • PL e	Requires functional safety board
	SS1	Safe Stop 1		
	SLS	Safely-Limited Speed		
	SBC	Safe Brake Control		
	SSM	Safe Speed Monitor		

*1. Certification is scheduled after 2024

Upgrade of Existing Automation Panel

It is possible to upgrade the existing automation panel with TMdrive-70e3 IoT features reusing the existing converter panel. (*2)

Upgrade example

- Reuse the converter panel and field control panel
- Update the existing automatic control panel completely

*2. The target models are as follows.

- TMdrive-P70 • 70
- TMdrive-P70e2 • 70e2
- TMdrive-P50 • 50

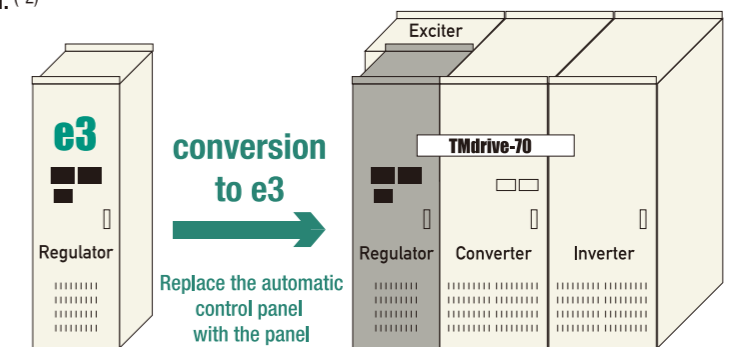

AC drive system update

The maximum output voltage of the inverter is 3650V, making it easy to upgrade using existing AC motors.

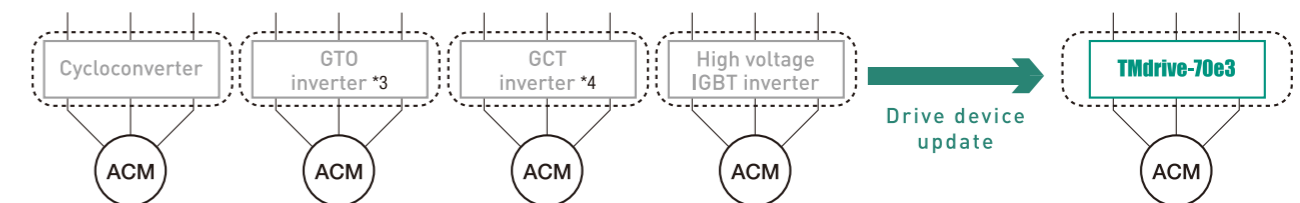

Existing AC adjustable speed drive system

*3.GTO : Gate Turn-Off thyristor

*4.GCT : Gate Commutated Turn-Off thyristor

Please contact us for information on whether the existing motor can be used.

Standard Specifications and Options

Item	Standard specifications		Options / remarks	
Standard	IEC, JIS, JEC, JEM			
Installation location	Indoor			
Altitude	Not exceed 1000 m above sea-level			
Ambient temperature	+ 5°C ~ 40°C			
Relative humidity	5% to 85% or less (no condensation)			
Converter PWM method	Fixed pulse pattern		Carrier comparison type	
Converter input voltage	3800 Vac		3300 Vac	
Allowable power supply voltage variation	Within ± 10%			
Regenerative method	Power regeneration by PWM converter			
Drive motor	Induction motor	Synchronous motor	Induction motor	Synchronous motor
Output voltage	max. 3500 Vac	max. 3300 Vac	max. 3650 Vac	max. 3400 Vac
Maximum output frequency	75 Hz			
Maximum rotation speed	2250 min ⁻¹ (4 pole)			
Speed sensor	Brushless resolver		PLG	
Control method	Speed control, torque control			
Speed control accuracy	± 0.01% (Digital speed reference)		± 0.1% (Analog speed reference, requires signal isolator)	
Speed control response	ωc = 60 rad/s (Max.)			
Speed control range	1 : 100		1 : 1000 (using high-precision resolver)	
Field weakening range	1 : 3		1 : 5	
Overload	100% - Continuous, 150% - 60s			
Load characteristic	Constant torque / constant power			
Paint color	JEM 1135 (1982) Munsell 5Y7 / 1 (Semi-gloss)	Specified color		
Panel protection structure	JEM 1267 (1997), IEC 60529, IEC 61800-5-1, IP20 Semi-dust-proof structure with bottom plate, with handle key		Up to IP43	
Air filter	Door front mounting type (replaceable with the door closed)			
Wire colors	IEC (EN60204-1) Electronic circuits, inside units, and special wires are excluded.		JEM 1122 (2011)	

*The above voltage and output capacity may be restricted by applicable motor load, reactive power compensation control, etc. Please contact us for details.

Panel Dimensions / 6 MVA Frame Series

Reference outline drawing (mm)	Banks Frame (kVA)	Losses (kW)	Mass (kg)	Rated current (A)	Overload capacity (60s)
	1 Bank 6,000	Internal (water) generated losses 72 External (air) emission losses 4	3,170	950	150%
				814	175%
				713	200%
				633	225%
				570	250%
	2 Banks 12,000	Internal (water) generated losses 144 External (air) emission losses 8	5,970	1,900	150%
				1,628	175%
				1,426	200%
				1,266	225%
				1,140	250%
	4 Banks 24,000	Internal (water) generated losses 288 External (air) emission losses 16	11,570	3,800	150%
				3,256	175%
				2,852	200%
				2,532	225%
				2,280	250%

Panel Dimensions / 9 MVA Frame Series

Reference outline drawing (mm)	Banks Frame (kVA)	Losses (kW)	Mass (kg)	Rated current (A)	Overload capacity (60s)
	1 Bank 9,000	Internal (water) generated losses 134 External (air) emission losses 7	4,270	1,430	150%
				1,226	175%
				1,073	200%
				953	225%
	2 Banks 18,000	Internal (water) generated losses 268 External (air) emission losses 14	8,170	2,860	150%
				2,452	175%
				2,146	200%
				1,906	225%
	3 Banks 27,000	Internal (water) generated losses 402 External (air) emission losses 21	12,070	4,290	150%
				3,678	175%
				3,219	200%
				2,859	225%
	4 Banks 36,000	Internal (water) generated losses 536 External (air) emission losses 28	15,970	5,720	150%
				4,904	175%
				4,292	200%
				3,812	225%
	4 Banks 36,000	Internal (water) generated losses 536 External (air) emission losses 28	15,970	3,432	250%
				2,574	250%

Flexible layout configuration

Automatic control panel and main circuit panel (converter / inverter) can be installed separately.

The distance between them can be extended up to 100m because they are connected by optical fibers.

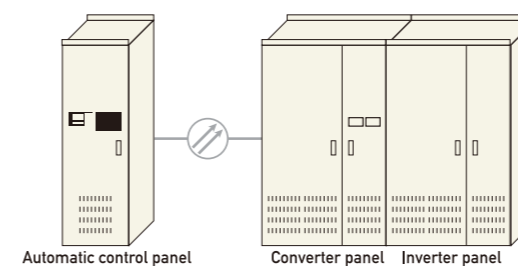

Panel back-to-back configuration is possible (6MVA model only).

The pure water-cooling unit can be installed side by side or separately. When space is limited, flexible panel arrangement is possible.

Side by side arrangement [6MVA model]

Back-to-back arrangement [6MVA model]

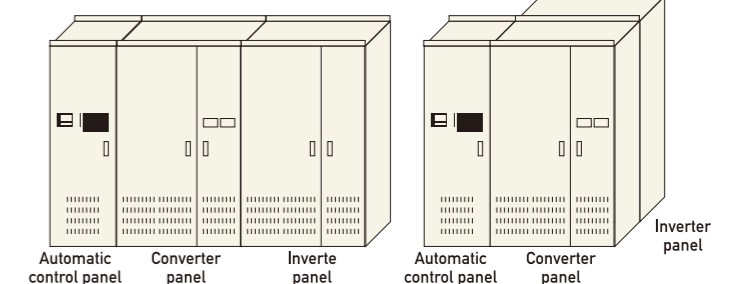

Panel Dimensions / 11 MVA Frame Series

Reference outline drawing (mm)	Banks Frame (kVA)	Losses (kW)	Mass (kg)	Rated current (A)	Overload capacity (60s)
	1 Bank 11,000	Internal (water) generated losses 134 External (air) emission losses 7	5,170	1,740	150%
				1,491	175%
				1,305	200%
				1,160	225%
				1,044	250%
	2 Banks 22,000	Internal (water) generated losses 268 External (air) emission losses 14	9,970	3,480	150%
				2,983	175%
				2,610	200%
				2,320	225%
				2,088	250%
	3 Banks 33,000	Internal (water) generated losses 402 External (air) emission losses 21	14,770	5,220	150%
				4,474	175%
				3,915	200%
				3,480	225%
				3,132	250%

Water Conditioning Equipment

Type	Capacity (kW)	Width (mm)	Depth (mm)	Height (mm)	Mass (kg)	Remarks (9MVA model)
Side by side	134	1,200	1,440	2,375	1,600	Industrial water 300 l/min For 1 bank type
Separate	268	1,200	1,590	2,375	1,700	Industrial water 600 l/min For 2 bank type
Separate	536	3,000	2,000	2,500	2,500	Industrial water 1,200 l/min For 4 bank type
Separate	804	4,300	2,000	2,500	4,300	Industrial water 1,800 l/min For 6 bank type



* A cooling capacity larger than the internal loss of the drive equipment is required. The above cases are examples. Please contact us for other cases.
* 1 bank consists of 1 converter and 1 inverter.
* The capacities and industrial water flow rates in the table above are for 9,000 or 11,000 frames.

Field Converter Panel

Reference outline drawing (mm)	Frame	Mass (kg)	Input voltage	Output current (Adc)	Overload capacity (60s)
	1,200A	400	600 Vac max. ± 10%, 50 / 60 ± 2 Hz	1,180	150%
				1,040	175%
				930	200%
				840	225%
				760	250%
	2,400A	1,000	750 Vac max. ± 10%, 50 / 60 ± 2 Hz	2,400	150%
				2,260	175%
				2,040	200%
				1,850	225%
				1,700	250%

Basic Configuration Example of TMdrive-70e3

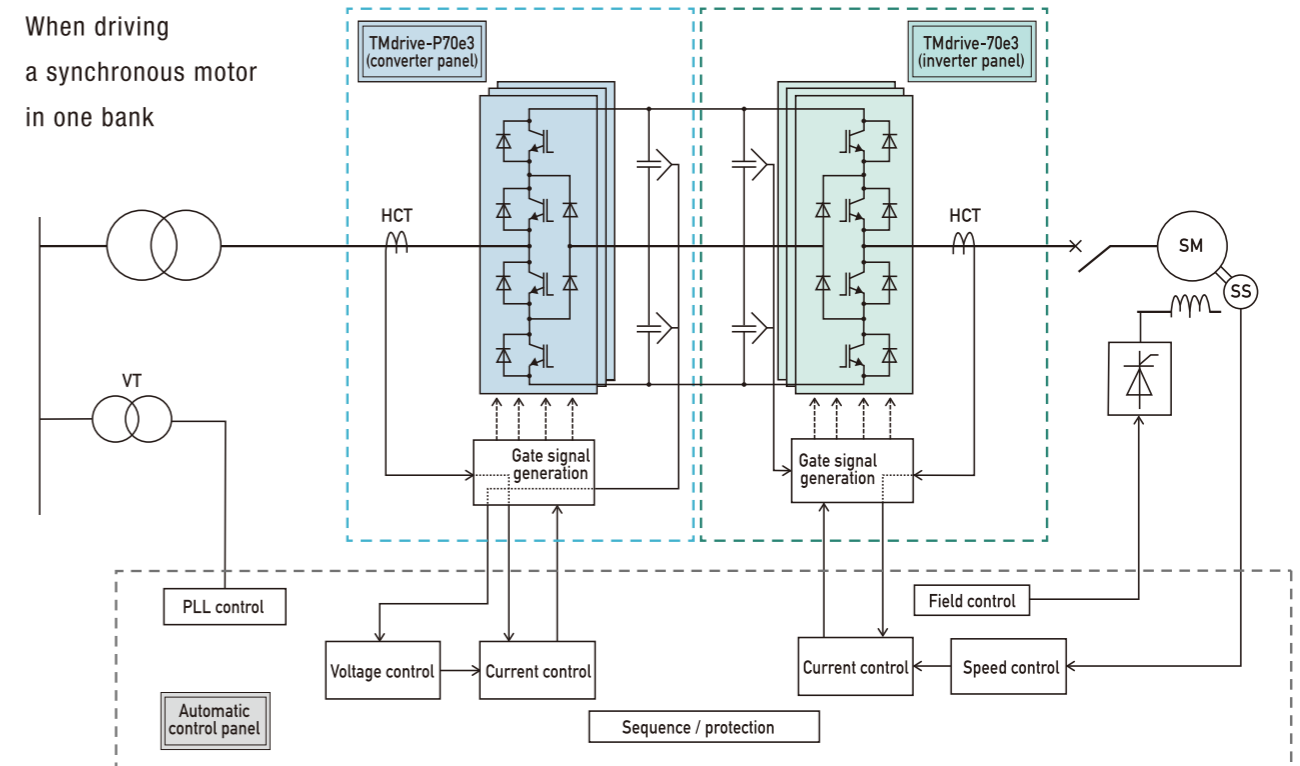

TMdrive-70e3 Notes

1. The 6MVA model requires a front maintenance space of 1,500 mm. The 9MVA and 11MVA models require a maintenance space of 2,000 mm in the front and 1,500 mm in the rear. A space of 1,000 mm above is required for fan maintenance.
2. When the pure water cooling system is installed separately, the cooling water piping will be connected to the flange at the bottom of the converter panel or inverter panel.
3. The standard cooling water (industrial water) inlet temperature is 32°C max. and 10°C min., and the outlet temperature is 36°C (when the inlet temperature is 32°C).
4. The output current value is the standard selection value. The voltage value is also related to various controls and may be handled differently depending on the applications.
5. Control power supply is 50 Hz - 200 V / 220 V or 60 Hz - 200 V / 220 V. Approximately 2.5 kVA per a converter and a inverter.
6. A 4.7 kVA - 50 / 60 Hz - 380 V / 440 V / 460 V power supply is required for pre-charge circuit.
7. Cables entries are from the bottom of the panels for both input and output. (Top cable entries are possible as an option.)
8. Please refer to the instruction manual for the replacement cycle of limited-life products.